

**Semiconductor**  
**Analyzers for**  
**Wet Process**

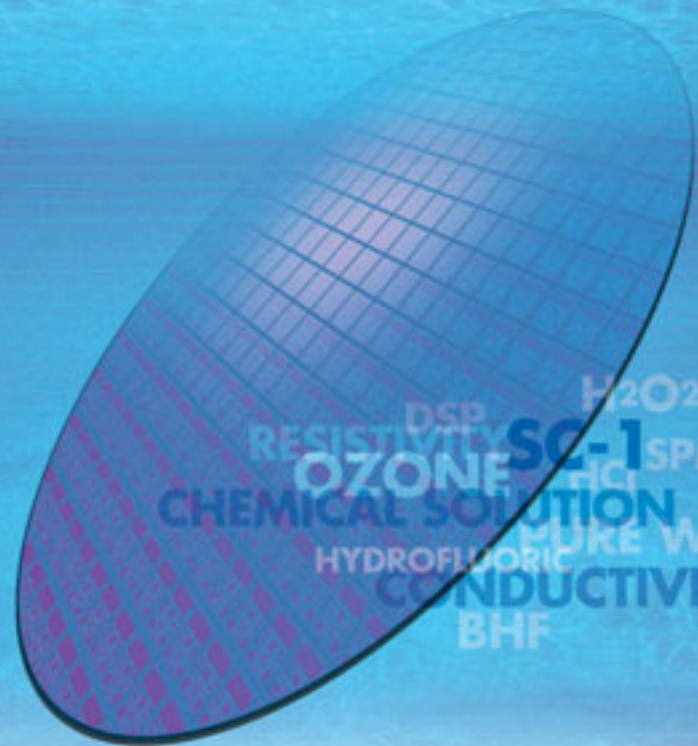

DSP H<sub>2</sub>O<sub>2</sub>  
RESISTIVITY SC-1 SPM  
OZONE HCl  
CHEMICAL SOLUTION  
HYDROFLUORIC PURE WATER  
CONDUCTIVITY  
BHF

# HORIBA Group Delivers Comprehensive Solutions to the Evolution of Semiconductor/FPD Wet Processes

Since the introduction of the chemical solution concentration monitor in 1995, HORIBA has developed a wide range of analyzers for wet processes using unique technologies. The chemical solution concentration monitor boasts a world-leading market share\*1 in 300 mm semiconductor wafer cleaning processes and continues to be the industry leader. And now, the concentration monitoring of chemical solutions must play a more advanced role as a vital part of the "monitor → feedback → control" process control according to the evolution of semiconductor processes. In response to next generation equipment, HORIBA Group draws upon and incorporates the ideas of specialists in various fields. HORIBA has also developed an IPA gas concentration monitor for measuring IPA vapors generated during wafer drying processes. The IPA gas concentration monitor makes it possible for HORIBA to offer total wet process density control solutions that meet all of its customers needs.

\*1 From HORIBA's 2010 research.

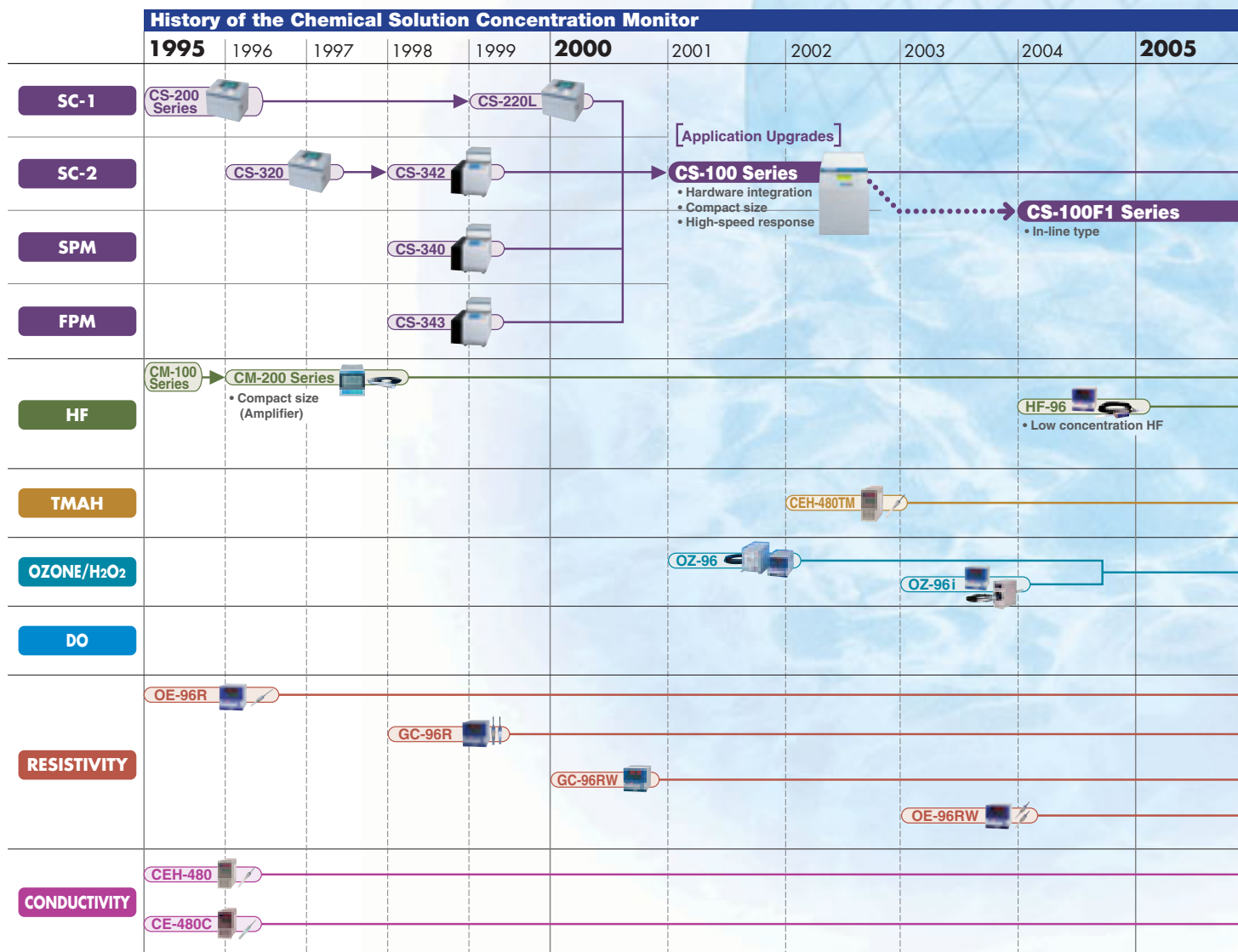

# HORIBA

## [ HORIBA ] Overall analysis technology specialist

HORIBA proprietary analysis technology is fully demonstrated in a wide range of fields - semiconductors, medicine, environment, science, and engine measurements. In semiconductors, HORIBA provides an extensive selection of process monitors for integration into manufacturing lines that aid the safe production of higher performance semiconductors.

## [ HORIBASTECH ] Mass flow control technology specialist

A core company in the HORIBA Group's semiconductor business, HORIBA STEC boasts a world-leading market share\*2 in industry-standard mass flow controllers and liquid source vaporization control systems, important devices that are vital in semiconductor manufacturing lines.

## [ HORIBAJOBIN YWON ] Optical analysis technology specialist

Based in France, this company is the leading manufacturer of spectroscopic ellipsometers and was welcomed into the HORIBA Group in 1997. Fusing proprietary HORIBA technology with spectroscopy that covers the infra-red to visible light ranges has established an analysis technology that covers the entire wavelength range.

## [ HORIBA Advanced Techno ]

### Water measurement technology specialist

HORIBA Advanced Techno manufactures leading edge products for the fields of environment, measurement and semiconductor cleaning. In semiconductors, its main products include equipment for measuring the concentration of Hydrofluoric Acid required in wafer etching and various other liquids, and equipment for measuring the purity of ultra-pure water that is vital in wafer cleaning processes.

\*2 From HORIBA STEC's 2011 research.

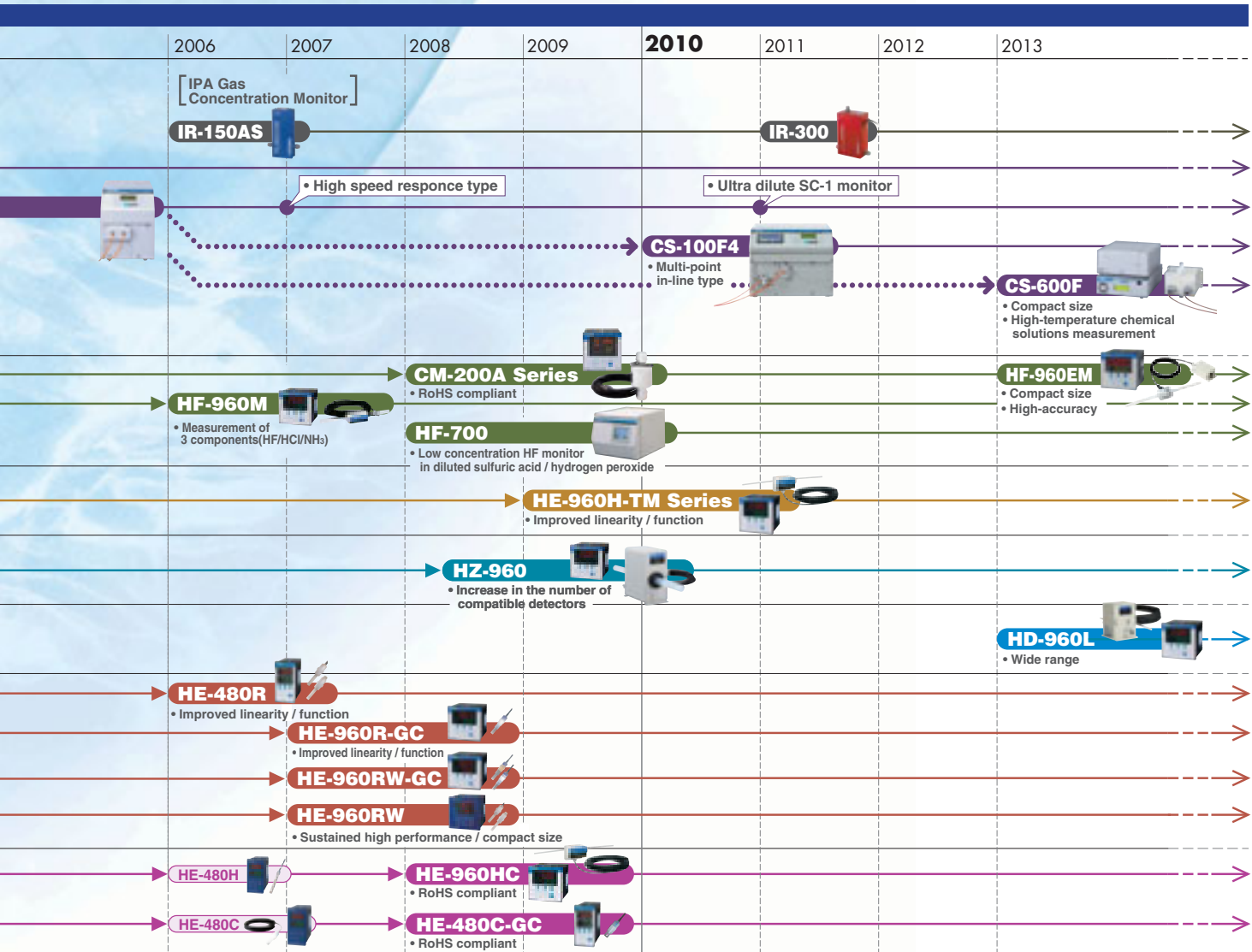

# FEOL & BEOL Chemical Solution/Gas Concentration Monitoring in Wet Process

## Semiconductor Processes

### Front-end of Line

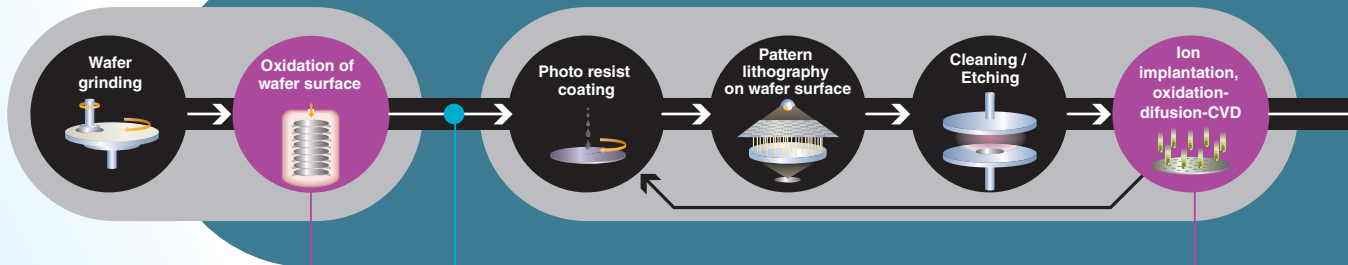

### Developing

**TMAH Concentration Monitor**  
**HE-960H-TM Series**

### RCA Cleaning Full Process

Organic material removing  
 $H_2SO_4/H_2O_2$

**SPM Monitor CS-150**

**Dissolved Ozone Monitor HZ-960**

**Support for Multi-Bath, Single-Bath, and Single-Wafer Cleaning Systems**

Diluted HF rinsing

**Fiber Optic Type Chemical Solution Concentration Monitor CS-600F**

**TMAH/H<sub>2</sub>O<sub>2</sub> Monitor CS-139E**

**Fiber Optic Type Chemical Solution Concentration Monitor CS-100F1 Series**

The CS-100F1 Series is available for measuring up to four types of chemical solutions and ranges. Please consult HORIBA about the details.

Particle removing  
 $NH_4OH/H_2O_2/H_2O$

Diluted HF rinsing

**Alternate RCA Monitor CS-100 Series**

\*Please consult HORIBA concerning chemical solutions.

Metal removing  
 $HCl/H_2O_2/H_2O$

Diluted HF rinsing

**SC-2 Monitor CS-152**

DIW rinsing

Spin/IPA drying

**IPA Gas Monitor IR-300**

**BHF Monitor CS-137**

**Hydrofluoric Acid Monitor HF-960EM**

**Dissolved Oxygen in Low Concentration HF Monitor HD-960L**

**Low Concentration HF/HCl/NH<sub>3</sub> Monitor HF-960M**

**Conductivity Meter (Low concentration type) HE-480C-GC**

**Resistivity Meter HE-480R**

**Carbon Sensor Resistivity Meter HE-960R-GC**

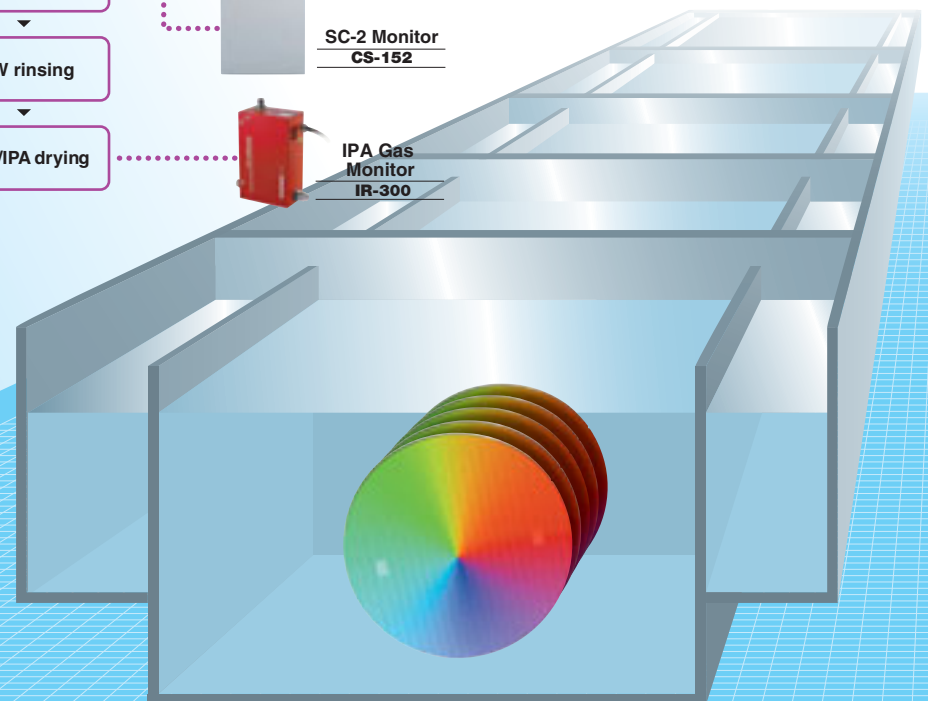

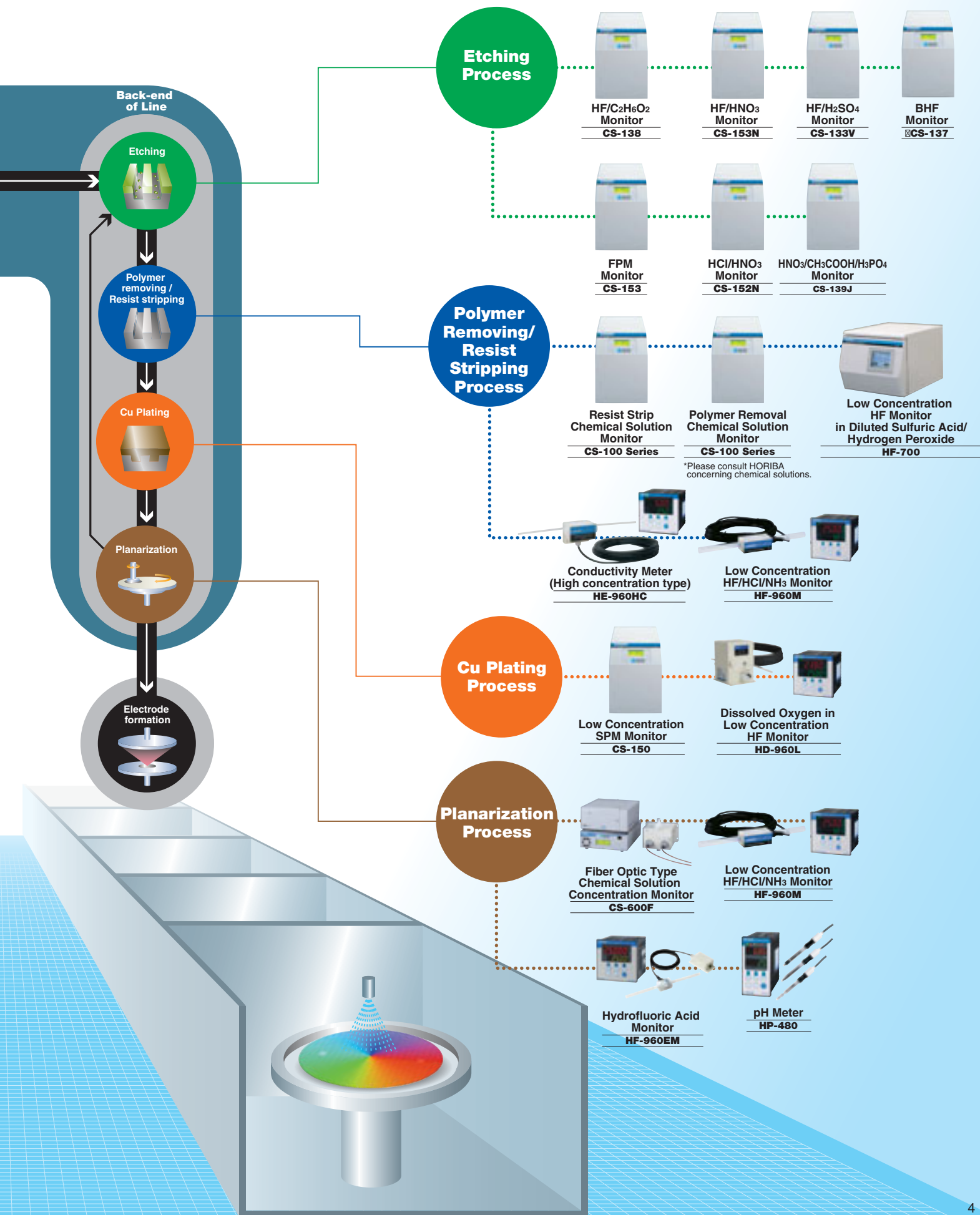

**Etching Process**

- HF/C<sub>2</sub>H<sub>6</sub>O<sub>2</sub> Monitor CS-138
- HF/HNO<sub>3</sub> Monitor CS-153N
- HF/H<sub>2</sub>SO<sub>4</sub> Monitor CS-133V
- BHF Monitor CS-137

**Polymer Removing/Resist Stripping Process**

- FPM Monitor CS-153
- HCl/HNO<sub>3</sub> Monitor CS-152N
- HNO<sub>3</sub>/CH<sub>3</sub>COOH/H<sub>3</sub>PO<sub>4</sub> Monitor CS-139J
- Resist Strip Chemical Solution Monitor CS-100 Series
- Polymer Removal Chemical Solution Monitor CS-100 Series
- Low Concentration HF Monitor in Diluted Sulfuric Acid/Hydrogen Peroxide HF-700

\*Please consult HORIBA concerning chemical solutions.

**Cu Plating Process**

- Conductivity Meter (High concentration type) HE-960HC
- Low Concentration HF/HCl/NH<sub>3</sub> Monitor HF-960M
- Low Concentration SPM Monitor CS-150
- Dissolved Oxygen in Low Concentration HF Monitor HD-960L

**Planarization Process**

- Fiber Optic Type Chemical Solution Concentration Monitor CS-600F
- Low Concentration HF/HCl/NH<sub>3</sub> Monitor HF-960M
- Hydrofluoric Acid Monitor HF-960EM
- pH Meter HP-480

# CHEMICAL SOLUTION CONCENTRATION

## Fiber Optic Type

In-line/  
Realtime  
Measurement

## Chemical Solution Concentration Monitor

### CS-100F1 Series

The CS-100F1 Series is equipped with fiber optics cable based on the CS-100 Series. It offers real-time, in-line measurements by directly integrating the sample cell into the cleaning system piping and by using a fiber optic cable for light signal transmission. A single concentration monitor can take up to four measurements and monitoring of multiple chemical solutions in a single-bath or single-wafer cleaning system is also possible.

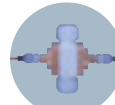

In-line cell

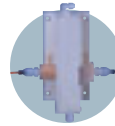

Cell unit

#### Concentration follow-up in real-time using in-line cells

Real-time concentration monitoring is made possible by using an in-line cell that directly connects to the main piping of the cleaning system.

#### Multi monitoring of up to four types

A single monitor can measure up to four types of chemical solutions or ranges. You can monitor the concentrations of more than one chemical solution (or differing chemical solution ratios) in a single lot, like single-bath or single-wafer cleaning system.

#### Cell unit type for higher accuracy

Emphasizing stability, a cell unit type is also available that supports feedback control using a monitor output. It is also possible to keep the chemical solution concentration within an accepted range and eliminate unnecessary chemical solution changes.

#### Safe installation by complete isolation of electrical and measurement sections

#### RoHS compliant

### Example of installation

#### In-line Type

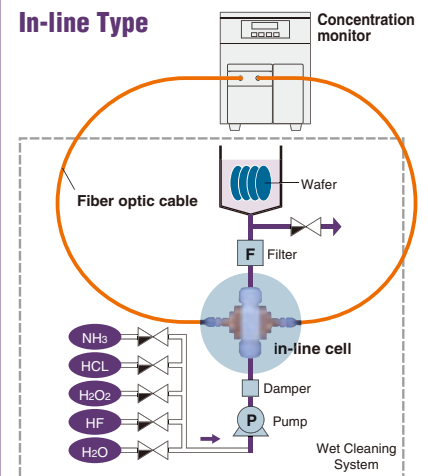

#### Cell Unit Type

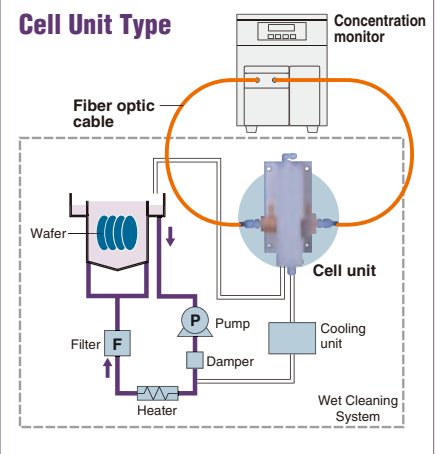

## New model measures complex chemical with high accuracy

## Chemical Solution Concentration Monitor

NEW

### CS-700 Series

- High Accuracy with Complex Chemicals
- Max 8 Components Measurable
- Stand Alone / Plug and Play
- RoHS Compliant



### Performance Data for Reference

#### [Measurement Range]

HNO<sub>3</sub>: 28.0 % to 30.0 %  
 HF: 3.00 % to 5.00 %  
 H<sub>3</sub>PO<sub>4</sub>: 33.0 % to 37.0 %  
 H<sub>2</sub>SiF<sub>6</sub>: 0.00 % to 3.00 %  
 H<sub>2</sub>O: 25.0 % to 36.0 %

#### [Repeatability (peak to peak)]

HNO<sub>3</sub>: ± 0.5 %  
 HF: ± 0.10 %  
 H<sub>3</sub>PO<sub>4</sub>: ± 0.6 %  
 H<sub>2</sub>SiF<sub>6</sub>: ± 0.50 %  
 H<sub>2</sub>O: ± 1.0 %

### Stability

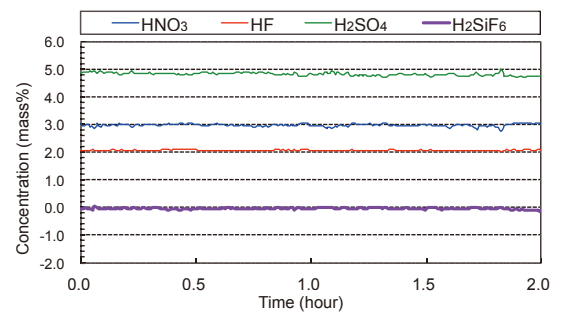

### Linearity

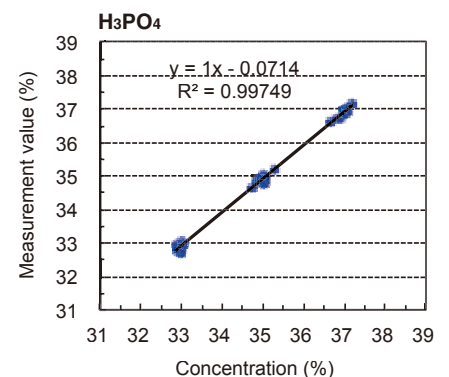
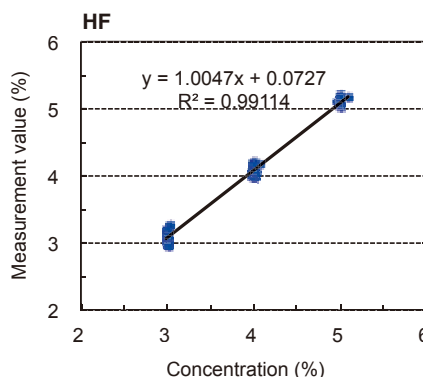
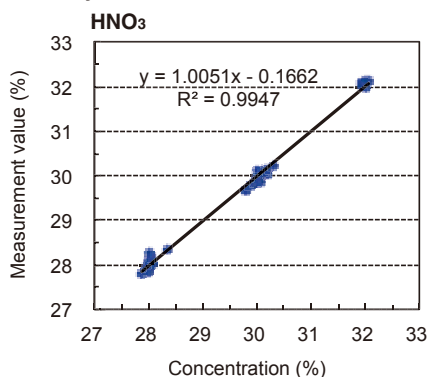

## Fiber Optic Type

# Chemical Solution Concentration Monitor

## CS-600F Series

High temperature  
Chemical  
Measurement

Stable  
operation

Compact  
body size

HORIBA's fiber optic type chemical solution concentration monitor, the CS-600F, achieves a higher level of functionality best suited for manufacturing, such as the ability to perform in-line measurement of high temperature chemical solutions in various applications, stable operation for reduced downtime, and compact size for improved space productivity in order to meet the precise chemical solution concentration management required in leading-edge semiconductor wet processes.

### Reduced Sizes for More Flexible Layout

The CS-600F monitor is compact in size; height has been reduced by 36%, volume by 40%, and the space required by the cell cables by 46% compared to previous models (CS-100F1 Series). The light source unit and monitor main body can be installed remotely and in separate locations, which allows installation flexibility based on the locations of the chemical solution unit and cleaning equipment.

### High-stability, In-line Measurement of High Temperature Chemical Solutions (20 to 80°C)

The all-new optical system and improved processing algorithms enable in-line measurement of high temperature chemical solutions, a critical step for leading-edge wet processes. This eliminates the need to cool-down the chemical sample., HORIBA's CS-600F provides a high-stability, enables more efficient and precise chemical solution management.

### Significantly Reduced Background Correction Frequency

The regular correction frequency is significantly reduced compared to the previous model (CS-100F1 Series), which in turn significantly reduces unit downtime and greatly contributes to improved throughput.



Example of installation

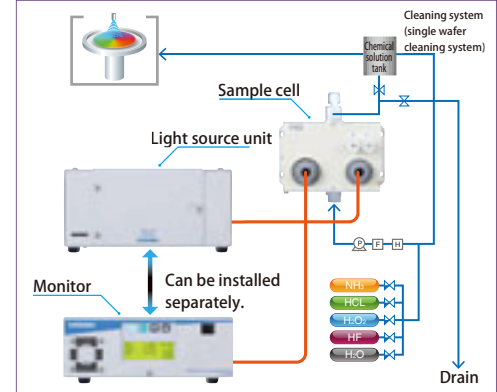

# Chemical Solution Concentration Monitor

## CS-100 Series

Plug-in/  
Plug-out

The CS-100 Series offers a complete lineup of high precision chemical solution concentration monitors for various solutions in cleaning and etching processes during semiconductor manufacturing. In addition to the high-speed response and compact design, measurement of each component concentration is conducted in real-time and the timing of chemical solution changes and automatic supply is warned with an alarm. The ability to perform short measurement cycles allows for accurate monitoring of concentration changes.



CS-100 Series



CS-100 Series  
(Integrated cooling unit)

### Concentration follow-up in real-time

Concentration control for the 300 mm process with an approximately 3 second measurement cycle is achieved. Frequent feedback is possible for both multi-bath and single-bath cleaning systems.

### Fully automatic measurements

Measurement is fully automatic, so no measurement control is required once the measurements have begun. The operator needs only to prepare the chemical solution. In addition, air is used for the reference spectral measurement, so a utility water supply used for usual measurements is unnecessary.

### Comprehensive measure to eliminate air bubble during sequential measurements

A unit with air bubble removing capability is installed upstream of the flow cell, allowing for consecutive measurements to be taken without abnormalities in the solution flow.

### A higher safety assurance by using 24 V DC

### Lightweight and compact design

### A higher overall yield

Output from the monitor is used for replenishment control of chemical solutions, enabling cleaning with a high reproducibility rate. There are fewer defects in the cleaning process, and this helps to boost the overall yield.

### RoHS compliant

Example of installation

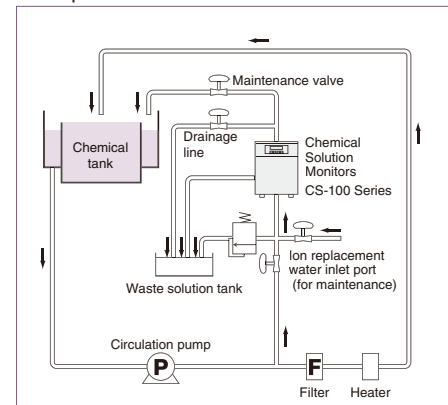

Example of chemicals can be measured

CS-100F1 Series / CS-121F1 / CS-100F4 Series / CS-100 Series

Measurement principle CS-100F1 Series / CS-121F1 / CS-100F4 Series / CS-100 Series

**Lambert-Beer's Law**  $A(\lambda) = \text{Log}[I_0(\lambda)/I(\lambda)] = \alpha(\lambda) \cdot L \cdot c \dots (1)$

$I_0(\lambda)$ : incident light     $I(\lambda)$ : light passed through the chemical solution  
 $\alpha(\lambda)$ : proportionality coefficient     $L$ : measurement cell thickness  
 $c$ : the concentration of the chemical solution

When light is irradiated into the water and chemical solution, absorption occurs of a specific wavelength that is dependent on the structure and type of substance. This level of absorption is called absorbance and the absorbance  $A(\lambda)$  of wavelength  $\lambda$  is expressed in (1), based on Lambert Beer's Law. It is now possible to perform quantitative analysis using the proportional relationship of concentration  $c$  and the absorbance  $A(\lambda)$  to find the concentration. Separation of the components that use absorbance data is required in order for the multiple components of the mixed solution to equal the light absorption of individual components. The CS Series allows the user to conduct chemical solution separation for up to four components using multivariate chemometrics analysis technique.

SC-1    SC-2    SPM    BHF

FPM    HF / HNO<sub>3</sub>    TMAH / H<sub>2</sub>O<sub>2</sub>

HF / EG    H<sub>2</sub>SO<sub>4</sub> / HF

HNO<sub>3</sub> / CH<sub>3</sub>COOH / H<sub>3</sub>PO<sub>4</sub>

Refer to the chemical solution monitor list on pages 13 and 14 for information on other chemical solution monitor models.

# HYDROFLUORIC ACID

## HF Concentration Monitor

### HF-960EM/CM-520L

The HF-960EM is equipped with a sensor for which the wetted part is only made from PFA, so the model completely complies with the cleanliness requirement of semiconductor processes. The sensor size has been reduced as much as possible, making it possible to install the model in a small space for single wafer processing in semiconductor wet processes. The stability and repeatability have been improved compared to previous models. The HF-960EM can provide wide measurement ranges of up to HF50% and it also achieves the rather wide range of 0 to 2,000 mS/cm of conductivity. These traits make this model most appropriate for measuring concentrations in various applications, required for introduction into the development stage of semiconductor processes as well as electric conduction management of special chemical solutions.



**Measurement sample:** Hydrofluoric acid  
**Measurement method:** Electromagnetic induction method  
**Measurement range:**  
 HF: 0 to 2%, 0 to 5%, 0 to 20%, 0 to 50%  
 HCl: 0 to 5%, 0 to 10%  
 Conductivity: 0 to 20mS/cm, 0 to 50mS/cm, 0 to 200mS/cm, 0 to 500mS/cm, 0 to 2000mS/cm  
**Repeatability:** ±0.5% of full scale  
**Response time:** 90% response within 0.5 seconds

Please consult HORIBA for measuring other chemicals than hydrofluoric acid.

#### Measurement principle

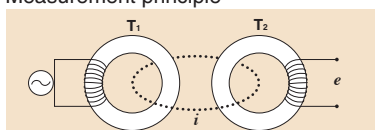

Two ring-core solenoids – excitation transformer  $T_1$  and detection transformer  $T_2$  – are molded inside the plastic shell of the sensor. When the sensor is immersed in the sample solution, the solution creates a closed circuit between the two solenoids. If a constant alternating current is then passed through the coil of solenoid  $T_1$ , a constant magnetic field is generated in the core and a current,  $i$ , flows through the sample solution in accordance with the conductivity of the sample. A magnetic field is generated in solenoid  $T_2$  in accordance with current  $i$  and an inductive electromotive force,  $e$ , (voltage) is proportional to the conductivity of the sample solution, conductivity can be ascertained by measuring  $e$ . Conductivity calculated in this way shows extremely high correlation with hydrofluoric acid concentration. The hydrofluoric acid concentration is calculated using the known reference curve and then displayed.



**Measurement method:** Carbon flow-through conductivity measurement and concentration conversion  
**Cell constant:** Approx. 4/cm  
**Temperature sensor specifications:**  
 Platinum resistance 1000°C/0°C 3850 ppm/°C  
**Measurement range:**  
 HF: 0 to 5000 ppm  
 HCl: 0 to 5000 ppm  
 NH<sub>3</sub>: 0 to 5000 ppm  
 Conductivity: 0 to 50.00/0 to 2.000 mS/cm  
 Temperature: 0°C to 100°C  
 (Selectable from one and two for the number of digits after the decimal point)  
**Repeatability:** ±25 ppm  
**Linearity:**  
 Within ±0.5% of the full scale (in equivalent input)

◆ Other models can measure various ranges are available

Model name		Measurement range	Repeatability
HF-960M-400	HF	0 to 5000 ppm	±25 ppm
		0 to 10000 ppm	±50 ppm
		0 to 15000 ppm	±75 ppm
HF-960H	HF	0 - 10.00%	±0.05%
	HCl		

## Optional HF value correction unit

### CX-05/CX-05A

- Correct HF concentration value increased by the H<sub>2</sub>SiF<sub>6</sub> and outputs the actual HF concentration.
- With parallel and analog output

**Display and Resolution:** 0.000 to 5.000%, 0.00% to 50.0%



- **Wide range of up to 50% HF concentration**

The automatic range-setting function provides the most appropriate measurement performance at each target concentration from low to high concentration.

- **Compact size and lightweight sensors**

The size has been reduced to two thirds (2/3) of the previous model and the weight has also been significantly reduced, allowing the HF-960EM to be placed more freely, for example, in front of the single wafer injection nozzle.

- **Contamination free and chemical resistant sensor**

Uses sensors for which the wetted parts are only made of PFA. The chemical resistant sensors can be used to measure various chemical solutions used in semiconductor processes.

- **High stability and repeatability**

The HF-960EM has a built-in sensor for measuring temperature, so it can measure HF samples up to 80°C, achieving a reproducibility accuracy of FS ± 0.5%.

- **RoHS compliant**

## Low Concentration HF/HCl/NH<sub>3</sub> Monitor

### HF-960M

With the evolution of 45 nm and 28 nm devices, RCA cleaning requires greater and greater low-concentration control. The HF-960M supports this need. It uses sensors that offer outstanding corrosion resistance for high-precision, high-speed measurement of low concentrations of hydrofluoric acid, hydrochloric acid and ammonia, and is thus perfect for single-bath and wafer cleaning.

- **Highly precise measurements of low HF concentrations**

The HF-960M provides highly precise measurement with ±25 ppm reproducibility. It supports control in the semiconductor etching process where the need for evermore detailed processing continues to increase. The 5000 ppm display resolution is equivalent to 0.5%. This ppm display is an answer to the demands for lower and lower concentrations.

- **Five types of measurements available: HF, HCl & NH<sub>3</sub> concentrations, conductivity, and temperature**

Temperature compensation measurement is carried out for HF, HCl & NH<sub>3</sub> concentrations based on the data for each temperature characteristic. The HF-960M can even be used as a conductivity meter for low-concentration dilution control of other chemical solutions as well.

- **The analog output range can be arbitrarily specified between 0 and 400% of the measurement range**

- **The HF-960M provides a diverse range of outputs; not only upper and lower concentration limits, but concentration errors outputs, and more**

- **Three transmission output systems allowing the desired data to be assigned**

- **Communication device ability (RS-485)**

- **RoHS compliant**

#### Installation example of HF sensors in wet station

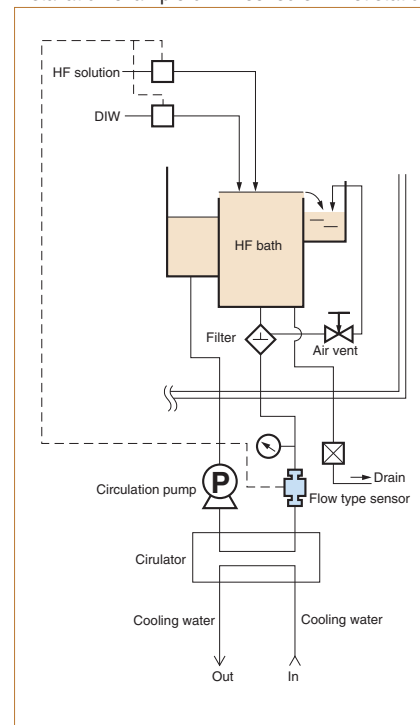

#### Measurement principle

$$\text{Conductivity (k)} = \frac{\text{Current (I)}}{\text{Voltage (E)}}$$

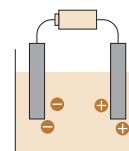

The conductivity obtained for each hydrofluoric acid, hydrochloric acid and ammonia water at 25°C after the relevant temperature compensation is then converted to a concentration value. Corrosion-resistant glass carbon is used for the electrodes.



# HF in DSP

## Low Concentration HF Monitor in Diluted Sulfuric Acid/ Hydrogen Peroxide

### HF-700

The HF-700 provides continuous and precise measurement of the low hydrofluoric concentration in the solution of diluted sulfuric acid, hydrogen peroxide and hydrofluoric acid that is used effectively in the removal of the polymer residue following the etching process.

#### Stable and continuous measurement

Continuous and precise measurement of the fluoride ion (ionized hydrofluoric acid) is achieved using automatic neutralizing function to neutralize the sample water continuously.

#### Multiple measurement modes to fit the application

The standard mode that gives priority to the response speed (NORMAL) and a reagent-saving mode that saves on reagent consumption (ECO) can be selected. In addition, the user can select a continuous measurement mode that measures concentrations and an intermittent measurement mode.

#### Built-in automatic calibration function

Calibration is done automatically with an external input signal.

#### Easy operation with a touch panel

The HF-700 adopts a graphical LCD touch panel screen. The easy-to-read and interactive display improves operation.

#### RoHS compliant



**Measurement method:** Fluoride ion electrode method

**Measurement range:** 0 to 1000 mg/L

**Number of transmission output:** 3

**Number of contact output:** 18

**Number of contact input:** 8

**Communication function:** RS-232C

**Sample condition:**

Sulfuric acid concentration: 2 to 15 wt%

Peroxide concentration: 0 to 20 wt%

Temperature: 10 to 35°C

Flow rate: 20 to 200 ml/min

Pressure: 0.05 to 0.1 Mpa

### Measurement principle

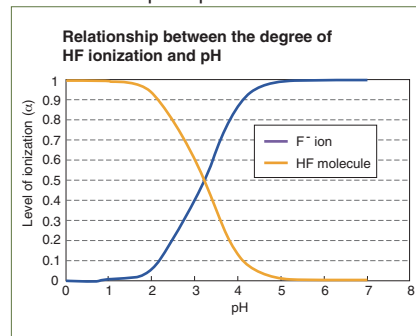

HF in an acid state goes no ionization. However, once it approaches a neutral state, the molecules are ionized and, at around pH 7, become almost 100% F<sup>-</sup> ions. The F<sup>-</sup> ion is measured with a fluoride ion electrode.

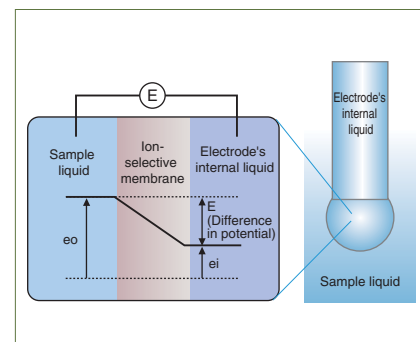

Based on the measurement of difference in potential generated by the ion concentration difference on either side of the ion-selective membrane. The difference in potential is measured on the basis of the comparison electrode immersed simultaneously in the sample liquid.

# pH

## Micro Volume Sampling pH Monitor

NEW

### UP-100

#### Micro sampling : 500 μL / 1 monitoring

Maximum 30mL / hour of sample consumption

#### Real-time measurement : every 1min. (minimum.)

#### Automatic calibration and KCl supply

Save maintenance cost!

(Labors, consumable, tool down time etc..)

Reagents last for 6 months without maintenance

#### RoHS Compliant



**Measurement method:** Glass electrode

**Measurement range:** 0 to 14 pH

**Repeatability:** ±0.10 pH  
(when monitoring pH4 standard solution)

**Temperature:** 20 to 60°C

### Measurement of pH in low concentration Ammonia

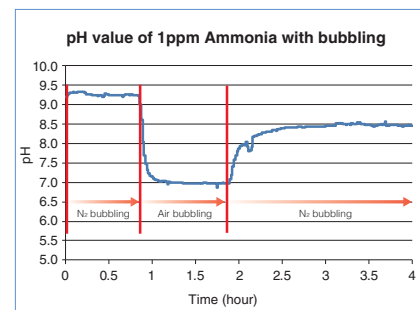

### Installation Example

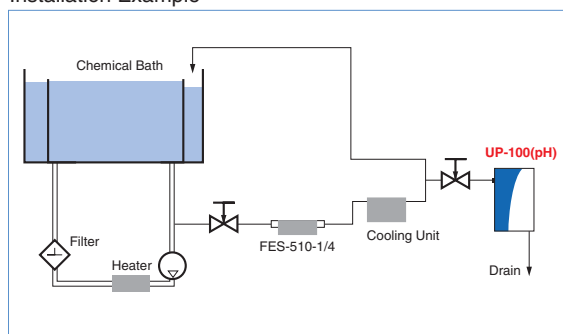

# TMAH/Citric Acid/KOH

## Chemical Concentration Monitor

HE-960H-TM Series  
HE-960CA  
HE-960H-KOH

HORIBA Conductivity based chemical concentration monitors offer precision measurement of various chemicals (TMAH, Citric acid and KOH). These monitors can be used simply for conductivity meter as well. HORIBA uses high chemical resistant 4-electrode sensor to offer wide range of measurement.

- Automatic decimal point adjustment enables a wide range measurement of various chemicals.
- Automatic range switching from high to low concentrations
- Enables three type of measurements: concentration, conductivity, and temperature
- Chemical resistant four-electrode glassy carbon sensor
- 4-channel transmission output
- 24 V DC power supply
- RoHS compliant



**Measurement method:**  
Electrode method (4-electrode method)  
**Cell constant:** 1.0/cm  
**Measurement range/repeatability:**

Model name (Sample)	Measurement Range	Repeatability
HE-960H-TM (TMAH)	0 - 10%	±0.5% of full scale
HF-960H-TM-S (TMAH)	0 - 3%	±0.003%
HE-960CA (Citric Acid)	0 - 2%	0 - 2000ppm ±1%RD or 5ppm whichever greater 0.2 - 2% ±1%RD or 0.005% whichever greater
HE-960H-KOH (KOH)	0 - 10%	±0.5%RD or 0.005% whichever greater

### Measurement principle

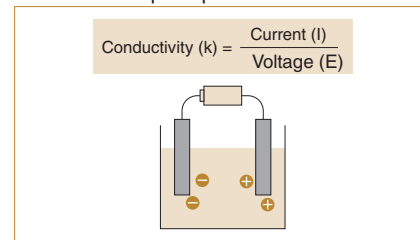

Combined with the 4-polar electric conductivity sensor, the conductivity of the 25°C TMAH is output using a method for measuring the current that flows when the applied voltage undergoes amplitude control to stabilize the detected voltage.

### Example of installation

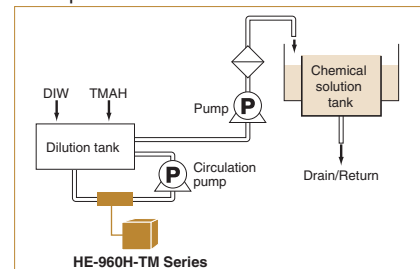

# OZONE/H<sub>2</sub>O<sub>2</sub>

## Dissolved Ozone Monitor H<sub>2</sub>O<sub>2</sub> Monitor

HZ-960 / HZ-960HPO-M

From the perspective of reducing costs and reducing the burden on the environment through chemical-less processes, the use of ozonated water is expected to be more and more effective. It monitors processes using a detector that can accurately monitor ozonated water and H<sub>2</sub>O<sub>2</sub> in-situ at both high and low concentrations.



**Measurement method:** UV absorption (254 nm)

### Ozone

**Measurement range:**  
ZH-10: 0 to 10 mg/L (Indicator resolution: 0.01 mg/L)  
ZH-40: 0 to 40 mg/L (Indicator resolution: 0.01 mg/L)  
ZH-100: 0 to 100 mg/L (Indicator resolution: 0.1 mg/L)  
ZH-500: 0 to 500 mg/L (Indicator resolution: 0.1 mg/L)

**Repeatability:**  
Within ±0.2% of full scale

**Stability:**  
Within ±0.5% of full scale/day  
(in equivalent zero point drift)

### H<sub>2</sub>O<sub>2</sub>

**Measurement range:**  
ZH-10HPO: 0 to 1000ppm  
ZH-40HPO: 0 to 4000ppm  
ZH-100HPO: 0 to 1%  
ZH-500HPO: 0 to 5%

**Repeatability:**  
Within ±0.2% of full scale

**Linearity:**  
Within ±1.0% of full scale

### Select between 2 types of detectors

Select from 2 types of detectors: sampling and in-line. The available detectors have pipe diameters of 1 inch, 3/4 inch, 1/2 inch and 1/4 inch. Selectable to fit the application and equipment environment.

### Wide measurement range

HZ-960 / HZ-960HPO-M offer 4 different measurement ranges, enabling control from low to high concentration in accordance with the purpose of use. (in-line type)

### High precision measurement

With zero point change stability within ±0.05% FS/day and reproducibility within ±0.2% FS/day, the HZ-960 makes it possible to maintain stabilized ozone water processes. (in-line type)

### Remote input and diverse output

### Easy-to-understand icon display for indicating instrument status

### Preventive of measurement errors and inadvertent operation with superior security functions

### CE Marking compliant

### RoHS compliant

### Measurement principle

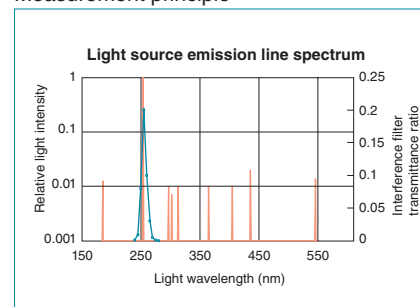

With the absorbance of 253.7 nm emission line from the low-pressure mercury lamp, concentration is converted to be output. There are 5 kinds of detectors available for different cell lengths according to concentration range.

### Example of installation

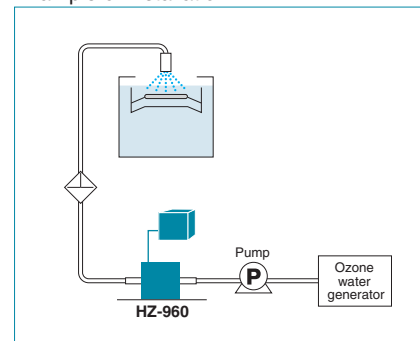

# CONDUCTIVITY

## Conductivity Meter

**HE-960HC**(High concentration type)  
**HE-960LC**(Low concentration type)

The sensor is a glassy carbon electrode that is highly resistant to chemicals. This allows the system to perform in-line measurements in high-stress environments. The concentration conversion feature makes it possible to operate the system in % display mode.

- **Wide range compatibility**
- **Concentration conversion function**  
(e.g. H<sub>2</sub>SO<sub>4</sub>, H<sub>3</sub>PO<sub>4</sub>, KOH, NaOH, etc.)
- **Equipped with a variety of control features, including transmission output (4 points), contact output (5 points) and contact input (1 point)**
- **Uses a chemical-resistant glassy carbon sensor (four-electrode type)**
- **in-line system can accommodate a wide range of applications, from small to large flow rate conditions**
- **RoHS compliant**



**Measurement method:** 4-electrode method  
**Temperature sensor specifications:**  
 Platinum resistance 1000°C/0°C  
 Coefficient 3850 ppm/°C standard

**HE-960HC**  
**Measurement range:**  
 Conductivity: 0 to 1000 mS/cm (Cell constant: 1.0/cm)  
 Temperature: 0 to 100°C  
**Repeatability:**  
 Within ±0.5% of full scale  
 Within ±1.0% of full scale at 200 to 1000 mS/cm  
**Linearity:**  
 Within ±0.5% of full scale  
 Within ±1.0% of full scale at 200 to 1000 mS/cm

**HE-960LC**  
**Measurement range:**  
 Conductivity: 0 to 1000µS/cm (Cell constant: 0.1/cm)  
 Temperature: 0 to 100°C  
**Repeatability:**  
 Within ±0.5% of full scale  
**Linearity:**  
 Within ±0.5% of full scale



**Measurement method:** 2-electrode method  
**Temperature sensor specifications:**  
 Platinum resistance 1000°C/0°C  
 Coefficient 3850 ppm/°C standard  
**Measurement range:**  
 Cell constant: 0.1/cm  
 Conductivity: 0 to 9999 µS/cm  
 Temperature: 0 to 100°C  
**Repeatability:**  
 Differs depending on specifications.  
 Contact a HORIBA customer service representative for more information.  
**Linearity:**  
 Differs depending on specifications.  
 Contact a HORIBA customer service representative for more information.

Measurement principle HE-960HC / HE-480C-GC

$$\text{Conductivity (k)} = \frac{\text{Current (I)}}{\text{Voltage (E)}}$$

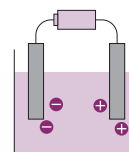

This is a method using the alternate current 2-polar electric conductivity sensor for measuring the current that flows when the applied voltage undergoes amplitude control to stabilize the detected voltage.

Example of installation HE-960HC / HE-480C-GC

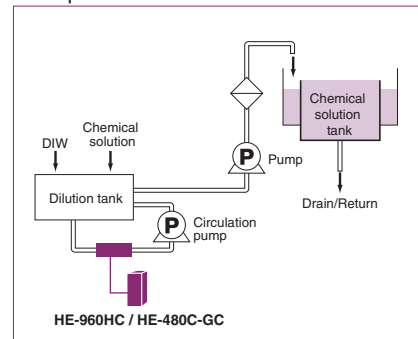

## Conductivity Meter

(Low concentration type)

**HE-480C-GC**

The length of the sensor has been reduced by 50% as compared to existing systems to reduce space requirements. At the same time, the measurement range has been increased tenfold, enabling the system to measure even samples with comparatively high concentrations. Two different types of chemical-resistant glassy carbon sensors can be used, making the system ideal for chemical dilution/recovery management and pure water recycling as well.

- **Designed especially for low- and medium-range conductivity measurements**
- **Compact unit design**
- **High pressure and chemical resistance**
- **Direct contact sensor design (ESH-1L-GC9 series)**
- **RoHS compliant**

# DO

## Disolved Oxygen Monitor

**HD-960L-M**

- **High sensitive measurement**  
Resolution: 0.1 ppb, Specification: 1 ppb
- **Chemical-resistant sensor**  
Wetted material : PP, PFA, PTFE, FEP
- **Minimized chemical consumption**  
Built-in stirrer
- **Easy maintenance**  
No Tool Needed
- **RoHS compliant**



**Measurement range:**  
 0 to 200µg/L, 200 to 2000µg/L,  
 2 to 20mg/L  
**Repeatability:**  
 ±1% of full scale  
**Linearity:**  
 ±1% of full scale

**Sample condition**  
**Flow rate:**  
 15 to 200 mL/min  
**Temperature:**  
 10 to 45 deg.C  
**Pressure:**  
 0 to 0.1 MPa  
**HF concentration:**  
 Less than 5700 ppm

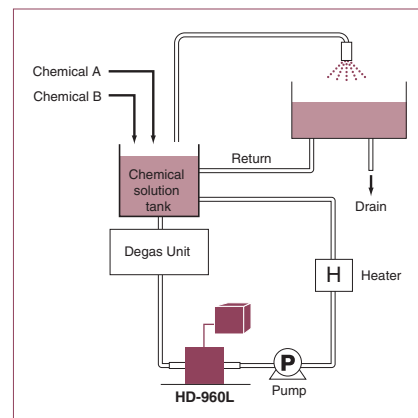

# RESISTIVITY

## Carbon Sensor Resistivity Meter

HE-960R-GC (1ch)

HE-960RW-GC (2ch)

The HE-960R-GC and HE-960RW-GC are resistivity meters using glassy carbon for its sensor. A glassy carbon sensor is not contaminated by metal elution and is chemically resistant to wet cleaning solutions such as hydrofluoric acid and hydrogen peroxide. The glassy carbon surface of its sensor is specially processed so that particle elution is also kept extremely small. It is especially effective for resistivity measurements in the rinse process of single-bath cleaning systems and it enables high quality control in the cleaning process.

- Superior chemical resistance allows for high quality control in single-bath cleaning
- Excellent high-speed response
- Selectable temperature compensation function
- Easy-to-understand icon display and superior security function
- 24 V DC power source
- CE Marking compliant
- RoHS compliant



**Measurement method:** 2-electrode method

**Sensor input:**

HE-960R-GC: 1 channel  
HE-960RW-GC: 2 channel

**Cell constant:** Approx. 0.1/cm

**Temperature sensor specifications:**

Platinum resistance 1000 Ω/ 0°C  
Temperature coefficient 3850 ppm/°C standard

**Measurement range:**

Measurement unit:  
0 to 2.00, 0 to 20.00, 0 to 200.0, 0 to 1000\* kΩ·m  
0 to 0.200, 0 to 2.00, 0 to 20.00, 0 to 100.0\* MΩ·cm  
\*: Measurable without temperature compensation  
Temperature: 0 to 100°C  
(Select your desired decimal point from 0, 1, and 2 digits)

**Repeatability:**

Within ±0.5% of full scale (in equivalent input)

**Linearity:**

Within ±0.5% of full scale (in equivalent input)

### Measurement principle

$$\text{Resistance (R)} = \frac{\text{Voltage (I)}}{\text{Current (E)}}$$

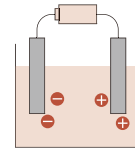

Applying alternate current voltage to the electrodes and reference resistor, the distribution voltage is measured and the solution resistance is measured. The cell constant and the revised purified water temperature compensation are added and then the 25°C resistivity is output. The superior, chemically resistant, glass carbon electrodes are available with the chemical solution rinse monitor.

### Example of installation HE-960R-GC

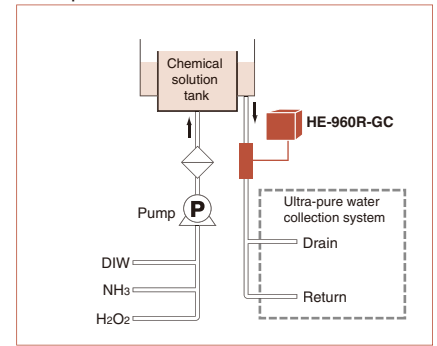

## Resistivity Meter

HE-480R

The HE-480R's onboard microprocessor calculates the temperature compensation coefficient based on the temperature characteristics of the ultra-pure water and automatically converts it to 25°C resistivity and precisely measures ultra-pure water during the process. This allows for highly precise temperature compensation in the range of 0 to 100°C. The HE-480R provides support for the close monitoring of ultra-pure water that is essential as part of the final process for cleaning silicon wafers.

- Perfect for monitoring resistivity of ultra-pure water in the final rinsing process
- Selectable temperature compensation function
- Selectable setting for standard temperature
- Simultaneous display of measured and set parameter values
- Easy-to-understand icon display and superior security function
- CE Marking compliant
- RoHS compliant



**Measurement method:** 2-electrode method

**Temperature sensor specifications:**

Platinum resistance 1000 Ω/ 0°C  
Temperature coefficient 3850 ppm/°C standard

**Measurement range:**

Resistivity: 0 to 2.00, 0 to 20.0, 0 to 200.0, 0 to 1000\* kΩ·m  
0 to 0.200, 0 to 2.00, 0 to 20.00, 0 to 100.0\* MΩ·cm  
\*: Measurable without temperature compensation  
Temperature: 0 to 100°C  
(Select your desired decimal point from 0, 1, and 2 digits)

**Repeatability:**

Within ±0.5% of full scale (in equivalent input)

**Linearity:**

Within ±0.5% of full scale (in equivalent input)

## High Resistivity Meter

HE-Z-100T

- Monitoring for aged and contaminated coolant high resistivity liquid
- Measuring T ohm·cm order resistivity
- High temperature/ pressure resistance
- RoHS compliant



**Measurement method:**

Electrode method (2-electrode)

**Measurement range:**

0 to 100TΩ·cm  
Temperature: 15 to 150°C (Non boiling solution)

**Repeatability:**

Within ±10%R.D.  
\*: Under the constant sample solution and ambient condition

**Linearity:**

Within ±5%F.S., Using equivalent input for resistivity

### Application example

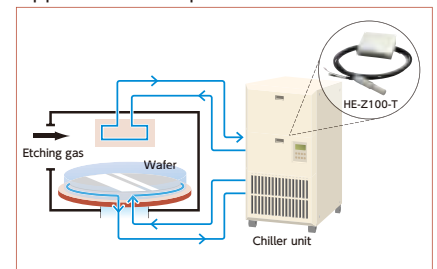

# ULTRA-PURE WATER

## Silica Monitor

### SLIA-300

The SLIA-300 High Sensitivity Silica Monitor perfectly meets the need for measurement below 1 µg/L (1 ppb) in ultra-pure water silica concentrations. It employs newly-developed, unique cell technology, allowing high sensitivity for handling measurements at low concentrations.

- High sensitivity in a compact body for silica analysis of ultra-pure water
- Reagent consumption reduced by 80%
- Up to 6-point measurement possible (option)
- Automatic calibration allows for superior maintainability
- Reliable light source eliminating need for replacement



**Measurement method:** Molybdenum blue method  
**Measurement range:** 0 to 2/0 to 20 µg/L or 0 to 5/0 to 50 µg/L (specified when ordering)  
**Repeatability:** ±2% of full scale  
**Measurement time:** 5 minutes  
**Measurement cycle:** 5 to 995 minutes  
**Indication:** Measuring value: 3.5 digits, 7-segment LCD  
 Guidance: 16 characters x 4 lines, dot matrix LCD  
**Measurement point:** 1 to 6 points (specified when ordering)  
**Calibration:** Standard calibration solution (from factory)

### Measurement principle SLIA-300

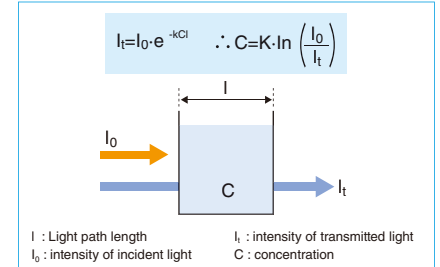

A molybdenum blue solution that responds to silica concentrations is fed to a long pathlength fiber cell. The absorption of near-infrared light (approximately 830 nm) is converted to silica concentration.

## For Ultra-pure Water Resistivity Meter

### HE-960RW

The HE-960W utilizes high precision, high stability temperature measurement circuit and a vastly improved temperature compensation function that is an important element for measuring the resistivity of ultra-pure water.

- Highly precise, highly stable temperature compensation function
- Fifty meters extension possible for sensor cables
- High temperature response of resistivity sensor
- Flexible analog transmission output
- Two-channel simultaneous measurement
- Four contact alarms
- Communication device ability (RS-485)



**Measurement method:** 2-electrode method  
**Sensor input:** 2-channel (for concurrent measurement with sensor isolated each other)  
**Cell constant:** Approx. 0.01/cm  
**Temperature sensor specifications:** Platinum resistance 1000 Ω/ 0°C  
 Temperature coefficient 3850 ppm/°C standard  
**Measurement range:** Resistivity: 0 to 2.00, 0 to 20.00, 0 to 1000.0\* MΩ-cm  
 0 to 20.00, 0 to 200.0, 0 to 1000\* kΩ-m  
 \*: Measurable without temperature compensation  
 Temperature: 0 to 100°C  
 (Select your desired decimal point from 0, 1, and 2 digits)  
 Desalination rate: 0% to 100%  
**Repeatability:** Within ±0.1% of full scale (in equivalent input)  
**Linearity:** Within ±0.5% of full scale (in equivalent input)

### Measurement principle HE-960RW

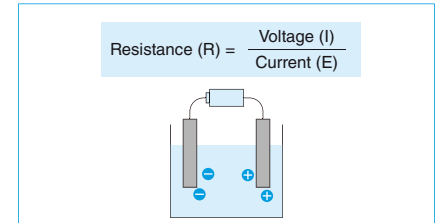

Applying alternate current voltage to the electrodes and reference resistor, the distributed voltage is measured and the solution resistance is measured. The cell constant and the revised purified water temperature compensation are added and then the 25°C resistivity is output. The HE-960RW is an ultra-pure water resistivity meter with a 2-channel simultaneous measuring circuit and high precision temperature compensation.

# WASTE WATER

## pH Meter with Automatic Calibration Function

### AH-151

- Simple Operation with Color Touch Panel LCD
- Easy Installation with Delivery in Units
- Reduction in Running Costs
- Enhanced Self-check Function
- RoHS compliant

**Measurement method:** Glass electrode method  
**Measuring range pH:** 0 to 14 Resolution: 0.01 pH  
**Temperature:** 0 to 100°C Resolution: 0.1 degree C  
 Display unit Touch panel (TFT color LCD)  
**Repeatability pH:** within ±0.02 pH, Temperature: ±0.3°C (Equivalent input)  
**Linearity pH:** within ±0.03 pH, Temperature: ±0.3°C (Equivalent input)



## Fluoride Ion Monitor

### HC-200F

- Wide range of measurements with 10 different levels from 0 to 10,000 mg/L.
- Implementing a silver ion trap structure to prevent blocking at the liquid junction
- Sensor cleaning timing can be adjusted by solenoid valve operation
- RoHS compliant

**Measurement method:** Internal cleaning timer  
**Measurement range:** 0.0 to 10.0, 0.0 to 20.0 mg/L (Resolution: 0.1 mg/L)  
 0 to 50, 0 to 100, 0 to 200 mg/L (Resolution: 1 mg/L)  
 0 to 500, 0 to 1000, 0 to 2000 mg/L (Resolution: 10 mg/L)  
 0 to 5000, 0 to 10000 mg/L (Resolution: 100 mg/L)  
**Repeatability:** Fluoride Ion: ±7% F.S. (excluding detection unit)  
 Temperature: ±0.3% (Equivalent input)  
**Linearity:** Fluoride Ion: ±10% F.S. (excluding detection unit)  
 Temperature: ±0.3% (Equivalent input)



# CHEMICAL SOLUTION CONCENTRATION MONITORS

PROCESS	CHEMICAL	Model	Measurement Range (%)						
Particle removal	SC-1 (APM)	CS-131 *	NH <sub>3</sub> 0-1	H <sub>2</sub> O <sub>2</sub> 0-1	H <sub>2</sub> O 98-100				
			0-1	0-5	94-100				
			0-3	0-7	90-100				
			0-0.3	0.5-1	98.7-99.5				
			0.2-0.8	0.2-0.8	98.4-99.6				
			0-5	0-10	85-100				
Particle removal	Alkali / H <sub>2</sub> O <sub>2</sub>	CS-151	NH <sub>3</sub> 0-0.3	H <sub>2</sub> O <sub>2</sub> 0-0.3	H <sub>2</sub> O 99.4-100				
			0.5-1.5	0-0.5	98-98.5				
			Particle removal	TMAH / H <sub>2</sub> O <sub>2</sub>	CS-121F1	NH <sub>3</sub> 0-0.1	H <sub>2</sub> O <sub>2</sub> 0-0.1	H <sub>2</sub> O 0-99.8	
					CS-159B	Alkali 0-0.5	H <sub>2</sub> O <sub>2</sub> 0-3	H <sub>2</sub> O 96.5-100	
					CS-139E	TMAH 0-0.5	H <sub>2</sub> O <sub>2</sub> 0-2	H <sub>2</sub> O 97.5-100	
					Metallic removal	SC-2 (HPM)	CS-152	HCl 0-2	H <sub>2</sub> O <sub>2</sub> 0-2
0-10	0-10	80-100							
0-15	0-5	80-100							
Post RCA	AM-1	CS-131	Shown above *						
	MC-1 / MC-1-SP	CS-131	Shown above *						
	Reps-203	CS-131	Shown above *						
Organic removal	SC-1 (APM)	CS-131	Shown above *						
			Alkali / H <sub>2</sub> O <sub>2</sub>	CS-159B	Alkali 0-0.5	H <sub>2</sub> O <sub>2</sub> 0-3	H <sub>2</sub> O 96.5-100		
					TMAH / H <sub>2</sub> O <sub>2</sub>	CS-139E	TMAH 0-0.5	H <sub>2</sub> O <sub>2</sub> 0-2	H <sub>2</sub> O 97.5-100
							SPM	CS-150 **	H <sub>2</sub> SO <sub>4</sub> 0-1
			0-10	0-10	80-100				
			10-20	20-30	50-70				
			30-60	10-20	20-60				
	50-90	0-10	8-50						
	70-96	0-5	4-30						
	90-98	0-1	2-10						
HCl	CS-152S	HCl 0-5	H <sub>2</sub> O 95-100						
		0-15	85-100						
H <sub>2</sub> O <sub>2</sub>	HE-960M	HCl 0-0.5							
		CS-152H	H <sub>2</sub> O <sub>2</sub> 0-10	H <sub>2</sub> O 90-100					
0-30	70-100								
O <sub>3</sub>	HZ-960	O <sub>3</sub> 0-0.01/0.02/0.04							
Polysilicon etching	NH <sub>3</sub>	HF-960M	NH <sub>3</sub> 0-0.5						
		CS-131S	NH <sub>3</sub> 0-0.2	H <sub>2</sub> O 99.8-100					
			0-1	99-100					
			0-5	95-100					
			0-29	71-100					
Resist removal	SPM	CS-150	Shown above **						
	CLK-888	CS-139K	XXXX 0.5-2	H <sub>2</sub> O <sub>2</sub> 1-5	Others 93-99				
BSG removal	H <sub>2</sub> SO <sub>4</sub> / HF	CS-133V	H <sub>2</sub> SO <sub>4</sub> 83-93	HF 0-5	H <sub>2</sub> O 2-17				
			80-96	1-5	4-19				
			HF 0.5-1.5	H <sub>2</sub> O 2-4.5	H <sub>2</sub> SO <sub>4</sub> 94-98				

PROCESS	CHEMICAL	Model	Measurement Range (%)			
Oxide removal	BHF	● CS-137	NH <sub>4</sub> F 0-10	HF 0-3	H <sub>2</sub> O 87-100	
			4-5	0.5-1.5	93.5-95.5	
			15-21	0-3	76-85	
			15-25	0-3	72-85	
			16-18	0-0.5	81.5-84	
			19-21	4-6	73-77	
			19-21	5-8	71-76	
			25-30	0-1	69-75	
			29-31	5-7	62-66	
			32-34	3-5	61-65	
			35-38	3-5	57-62	
			37-39	1-3	58-62	
	39-40	0-0.5	59.5-61			
	FPM	● CS-153	HF 0-0.5	H <sub>2</sub> O <sub>2</sub> 0-9	H <sub>2</sub> O 90.5-100	
			0-1.5	0-1	97.5-100	
			0-10	0-10	80-100	
	DHF	● CS-133U-O2P2	HF 0-2	H <sub>2</sub> SiF <sub>6</sub> 0-0.2	H <sub>2</sub> O 97.8-100	
			● CS-133U-1002	HF 0-10	H <sub>2</sub> SiF <sub>6</sub> 0-2	H <sub>2</sub> O 88-100
			● CM-210	HF 0-1/2/5/10/20/50		
			● HF-960H	HF 0-10		
			● HF-960M	HF 0-0.1/0.5/2		
Oxide/Ni etching	HF/Ethylene glycol	● CS-138	HF 0-5	H <sub>2</sub> O 0-10	EG 85-100	
			5-10	7-12	78-88	
		● CS-138W	HF 0-5	EG 85-100	H <sub>2</sub> O 0-10	
			0-5	0-10	85-100	
Al etching	HNO <sub>3</sub> /CH <sub>3</sub> COOH/H <sub>3</sub> PO <sub>4</sub>	● CS-139J	HNO <sub>3</sub> 0-5	CH <sub>3</sub> COOH 0-3	H <sub>3</sub> PO <sub>4</sub> 65-75	
			1-3	8-12	70-75	
			1.5-5.5	9-11	65-75	
			4-6	8-10	65-70	
			4-7	7.5-10.5	69-75	
			8-13	8-13	60-65	
Polymer removal	HNO <sub>3</sub> /HF	● CS-153N	HNO <sub>3</sub> 60-70	HF 0-5	H <sub>2</sub> O 25-45	
			50-60	5-10	30-45	
			57-65	3-8	27-40	
			69-70	0-0.5	29.5-31	
			68.5-70	0-1	29-31	
	H <sub>2</sub> O/Amine	● CS-135B	H <sub>2</sub> O 26-50	A.B.F 3-10	AMINE 45-71	
			● CS-135D	H <sub>2</sub> O 10-30	Others 70-90	
	EF-1	● CS-135E	HF 0-0.2	H <sub>3</sub> PO <sub>4</sub> 0.2-5	Others 94.8-99.8	
	ALKALI	● CS-139R	ALKALI 2-3	H <sub>2</sub> O <sub>2</sub> 0-3	Others 94-98	
Low-K etching	LK-1	● CS-135A	H <sub>2</sub> O 90-100	XXX 0-10		
Others	HNO <sub>3</sub> /HCl	● CS-152N	HNO <sub>3</sub> 5-12	HCl 15-25	H <sub>2</sub> O 63-80	
			8-10	17-21	69-75	
	HF/HCl	● CS-133A-12	HF 0-1	HCl 0-2	H <sub>2</sub> O 97-100	
			● CS-133A-15	HF 0-1	HCl 0-5	H <sub>2</sub> O 94-100-2
	TMAH	● CS-133A-55	HF 0-5	HCl 0-5	H <sub>2</sub> O 90-100-2	
● CS-139ES			TMAH 0-25	H <sub>2</sub> O 75-100		
	● HE-960H-TM	TMAH 0-10				

Notes: ● Please contact HORIBA as to the details of the specifications of each model as well as regarding the possible chemicals and ranges to be measured.  
 ● Fiber type models are also available for all models in the above list.

# Our worldwide service network ensures speedy support, when and where you need it.

## U.K.

HORIBA UK Limited



Kyoto Close  
Moulton Park, Northampton  
NN3 6FL, England  
Phone: 44-1604-542600  
Fax: 44-1604-542696

## China

HORIBA (China) Trading Co., Ltd.



● **Shanghai Office**  
Unit D, 1F, Building A, Synnex  
International Park, 1068  
West Tianshan Road,  
Shanghai, 200335, China  
Phone: 86 (21) 6289-6060  
Fax: 86 (21) 6289-5553

● **Beijing Office**  
12F, Metropolis Tower, No.2,  
Haidian Dong 3 Street,  
Beijing, 100080, China  
Phone: 86 (10) 8567-9966  
Fax: 86 (10) 8567-9066

● **Shenzhen office**  
Room 3E, Unit 3, Building 5,  
Youpinjianzhu Estate, Longhua  
District, Shenzhen, China  
Phone: 86 13602530661

● **Xi'an office**  
Room 411, Building A,  
South Fenghui Road, No 36,  
Xiangshu Street, Xian, China  
Phone: 86 (29) 88868480  
Fax: 86 (29) 88868481

## Japan

HORIBA Advanced  
Techno, Co., Ltd.



31 Miyano-nishi  
Kisshoin, Minami-ku  
Kyoto, Japan  
Phone: 81-75-321-7184  
Fax: 81-75-321-7291

HORIBA STEC,  
Co., Ltd.



11-5, Hokodate-cho  
Kamitoba, Minami-ku  
Kyoto, Japan  
Phone: 81-75-693-2300  
Fax: 81-75-693-2350

HORIBA TECHNO  
SERVICE Co., Ltd.



2 Miyano Higashi, Kisshoin  
Minami-ku, Kyoto, Japan  
Phone: 81-75-325-5291  
Fax: 81-75-315-9972

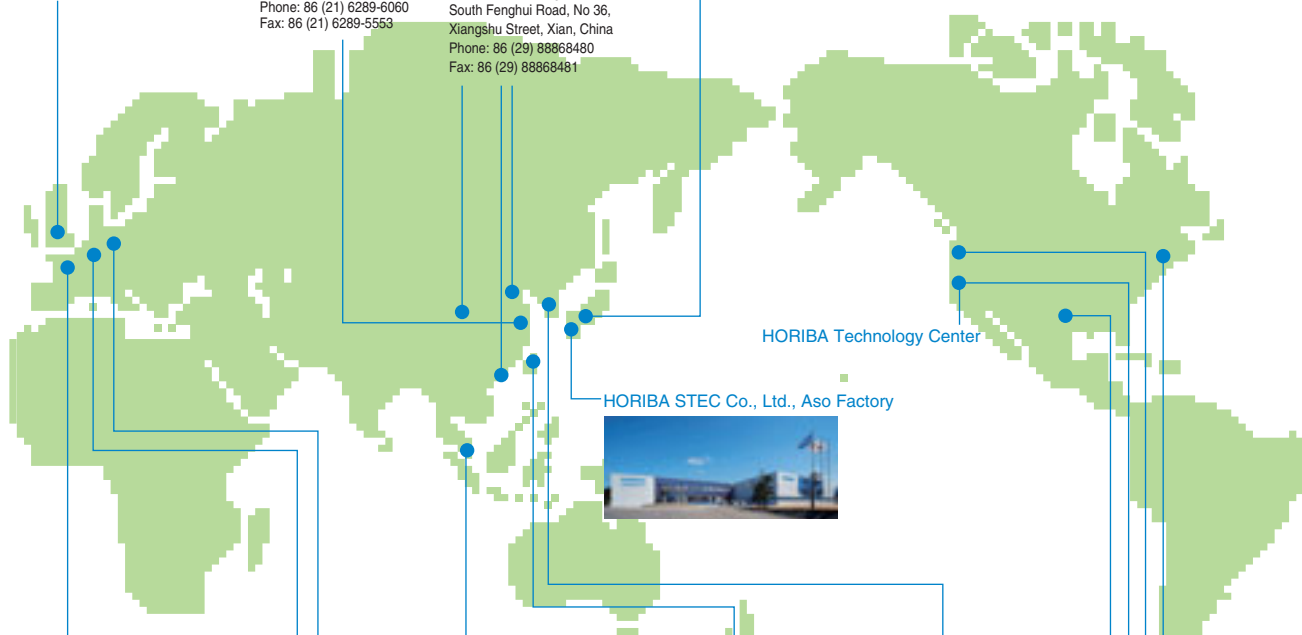

## France

HORIBA UK Ltd.  
Grenoble office



2B avenue de vignate  
38610 Gieres France  
Phone: 33 (4) 76 42 07 58

## Germany

HORIBA EUROPE  
GmbH



● **Oberursel Office**  
Hans-Mess-Str.6,  
D-61140 Oberursel  
Germany  
Phone: 49-6172-1396-0  
Fax: 49-6172-137385

● **Dresden Office**  
Hugo-Junckers-Ring  
1 01109 Dresden Germany  
Phone: 49-3518-896807  
Fax: 49-3518-896808

## Singapore

HORIBA INSTRUMENTS  
(SINGAPORE) Pte. Ltd.



3 Changi Business Park  
Vista #01-01  
Akzonobel House,  
Singapore 486051  
Phone: 65 (6) 745-8300  
Fax: 65 (6) 745-8155

## Taiwan

HORIBA  
Taiwan, Inc.



8F.-8, No.38, Taiyuan St.  
Zhubei City, Hsinchu County  
30265, Taiwan (R.O.C.)  
Phone: 886 (3)-560-0606  
Fax: 886 (3)-560-0550

## Korea

HORIBA STEC  
KOREA, Ltd.



98, Digital valley-ro Suji-gu,  
Yongin-si Gyeonggi-do  
16878 Korea  
Phone: (82)31-8025-6500  
Fax: (82)31-8025-6599

## U.S.A.

HORIBA Instruments  
Incorporated



● **Sunnyvale Head Office (Technology Center)**  
430 Indio way, Sunnyvale California 94085  
Phone: 1-408-730-4772 Fax: 1-408-730-8975

● **Austin Office**  
9701 Dessau Road Suite 605, Austin,  
TX 78754, U.S.A.  
Phone: 1-512-836-9560 Fax: 1-512-836-8054

● **Portland Office**  
10110 SW Nimbus Ave.,  
#B-11, Portland, OR 97223, U.S.A.  
Phone: 1-503-624-9767 Fax: 1-503-968-3236

● **Reno Office (R&D Center)**  
605 Spice Island Drive, #5 Sparks, Nevada 89431  
Phone: 1-775-358-2332 Fax: 1-775-358-0434

● **Albany Office**  
Suite 104, 58 Clifton Country Rd, Clifton Park,  
New York 12065, U.S.A.  
Phone: 1-518-331-1371

<http://www.horiba.com>



The HORIBA Group adopts IMS (Integrated Management System) which integrates Quality Management System ISO9001, Environmental Management System ISO14001, and Occupational Health and Safety Management System OHSAS18001. We have now integrated Business Continuity Management System ISO22301 in order to provide our products and services in a stable manner, even in emergencies.



Please read the operation manual before using this product to assure safe and proper handling of the product.

- The contents of this catalog are subject to change without prior notice, and without any subsequent liability to this company.
- The color of the actual products may differ from the color pictured in this catalog due to printing limitations.
- It is strictly forbidden to copy the content of this catalog in part or in full.
- All brand names, product names and service names in this catalog are trademarks or registered trademarks of their respective companies.

Bulletin: HAE-S0203A

Printed in Japan 1901SK23